

- Straight Sub-D 25 pin female connector with axial cable

Product code: G3X-25

Datasheet creation date: 20/05/2026 06:52

Check the most updated document online [click here](#)



■ TECHNICAL DATA

Mod.	G3X-25
------	--------

- Straight Sub-D 25 pin female connector with axial cable

Product code: G3X-25

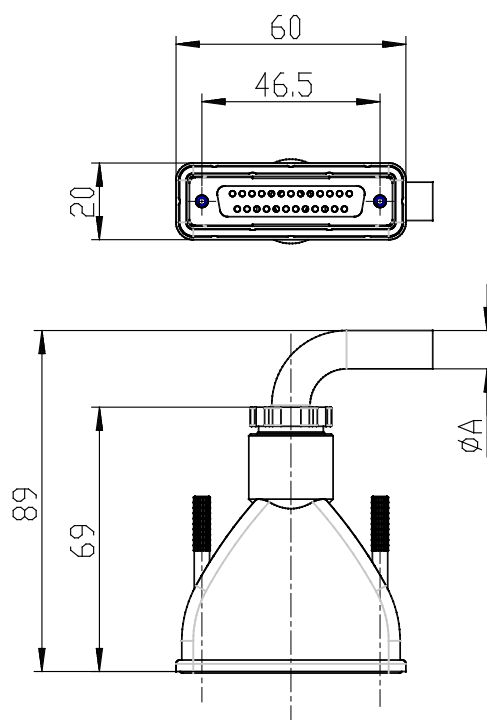

■ DIMENSIONS

A (mm)	7.7
Pin	15
Cable length [L] (m)	25