

Mod. G6590 - Fittings Series 7000 - Automation

Product code: G6590 8

Datasheet creation date: 19/05/2026 20:52

Check the most updated document online [click here](#)



■ TECHNICAL DATA

Mod.	G6590 8
------	---------

Mod. G6590 - Fittings Series 7000 - Automation

Product code: G6590 8

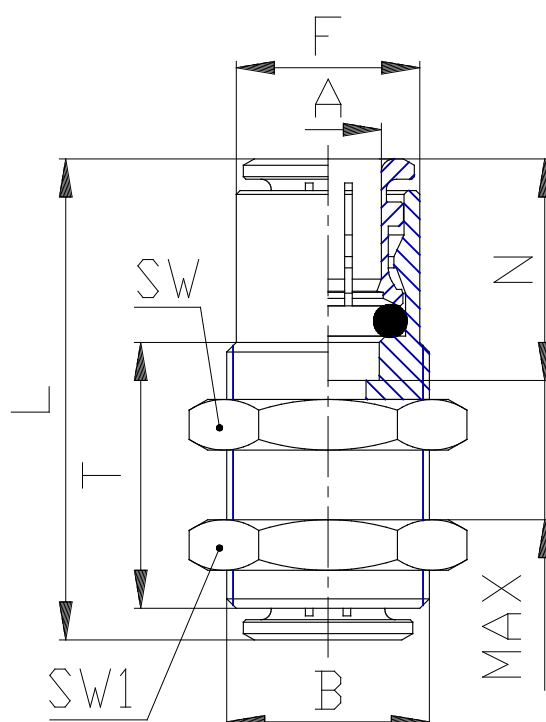

DIMENSIONS

A (mm)	8
B	M16x1
F (mm)	14.5
L (mm)	37.0
N (mm)	17.3
MAX (mm)	11.5
SW (mm)	19
SW1 (mm)	19
T (mm)	21
Weight (g)	26