

Mod. G6750 - Fittings Series 7000 - Automation

Product code: G6750 12

Datasheet creation date: 20/05/2026 09:25

Check the most updated document online [click here](#)



■ TECHNICAL DATA

Mod.	G6750 12
------	----------

Mod. G6750 - Fittings Series 7000 - Automation

Product code: G6750 12

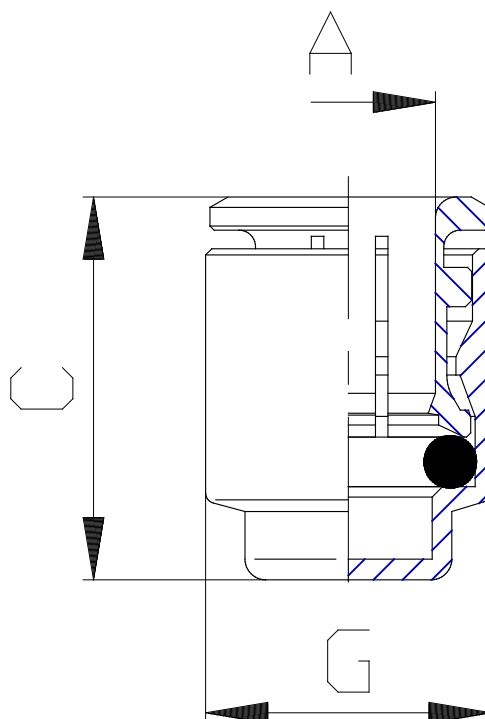

DIMENSIONS

A (mm)	12
G (mm)	19.7
L (mm)	23.5
Weight (g)	17