

Mod. G7450 - Fittings Series 7000 - Automation

Product code: G7450 4-1/8

Datasheet creation date: 10/03/2025 09:12

Check the most updated document online [click here](#)



■ TECHNICAL DATA

Mod.	G7450 4-1/8
------	-------------

Mod. G7450 - Fittings Series 7000 - Automation

Product code: G7450 4-1/8

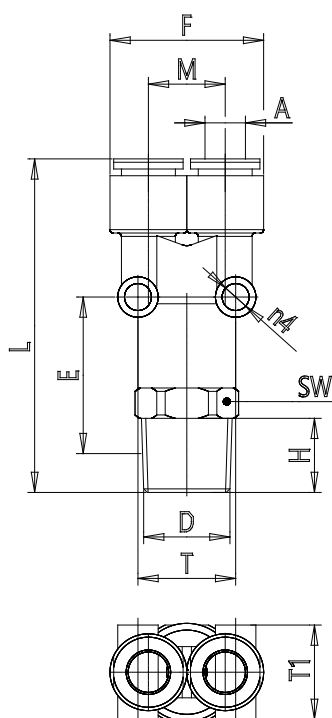

DIMENSIONS

A (mm)	4
D	R1/8
E (mm)	19.7
F (mm)	18.5
H (mm)	7.5
L (mm)	42.0
M (mm)	9.2
S (mm)	4
T (mm)	12.2
T1 (mm)	11.6
SW (mm)	12
Weight (g)	11