

## Mod. G7520 - Fittings Series 7000 - Automation

Product code: G7520 10-1/2

Datasheet creation date: 20/05/2026 08:20

Check the most updated document online [click here](#)



### TECHNICAL DATA

Mod.	G7520 10-1/2
------	--------------

## Mod. G7520 - Fittings Series 7000 - Automation

Product code: G7520 10-1/2

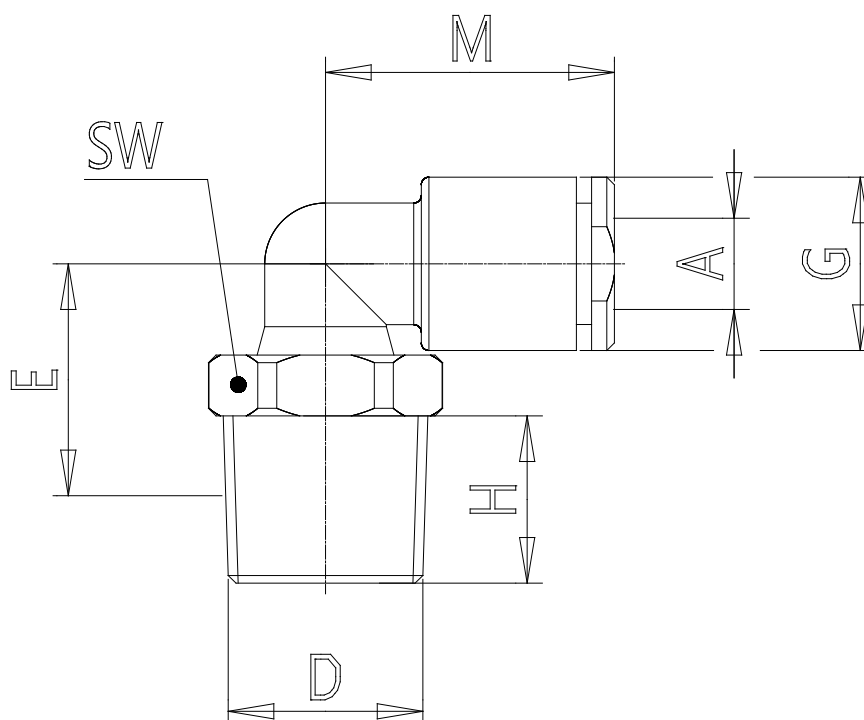

### DIMENSIONS

<b>A (mm)</b>	10
<b>D</b>	R1/2
<b>E (mm)</b>	18.5
<b>G (mm)</b>	16.3
<b>H (mm)</b>	14.0
<b>M (mm)</b>	25.0
<b>SW (mm)</b>	22
<b>Weight (g)</b>	48.0