

Mod. G7520 - Fittings Series 7000 - Automation

Product code: G7520 12-1/2

Datasheet creation date: 20/05/2026 08:18

Check the most updated document online [click here](#)



■ TECHNICAL DATA

Mod.	G7520 12-1/2
------	--------------

Mod. G7520 - Fittings Series 7000 - Automation

Product code: G7520 12-1/2

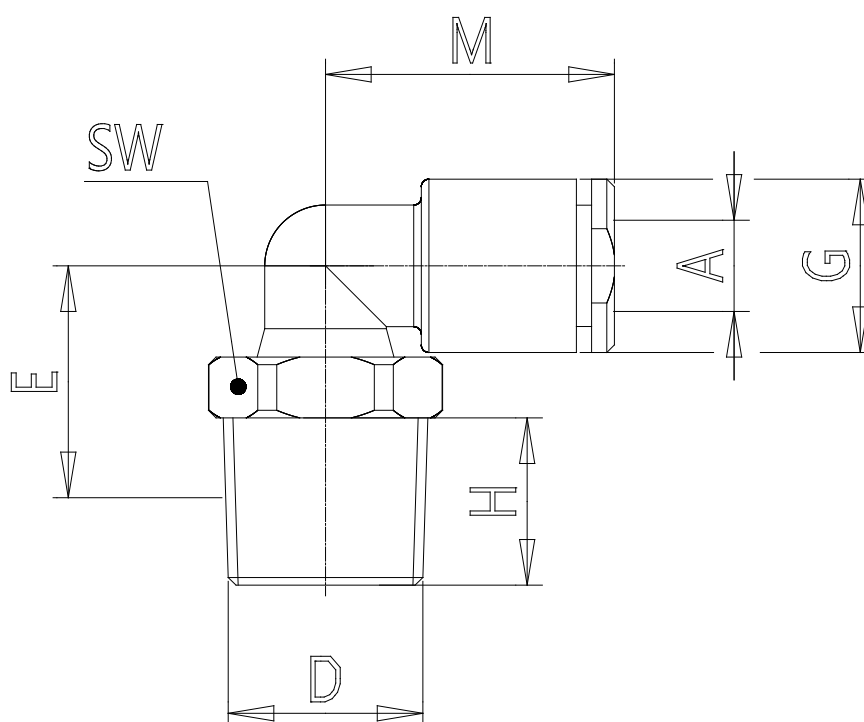

DIMENSIONS

A (mm)	12
D	R1/2
E (mm)	19.5
G (mm)	20.0
H (mm)	14.0
M (mm)	31.0
SW (mm)	22
Weight (g)	47.0