

## Mod. G7520 - Fittings Series 7000 - Automation

Product code: G7520 4-1/4

Datasheet creation date: 10/03/2025 09:12

Check the most updated document online [click here](#)



### TECHNICAL DATA

Mod.	G7520 4-1/4
------	-------------

## Mod. G7520 - Fittings Series 7000 - Automation

Product code: G7520 4-1/4

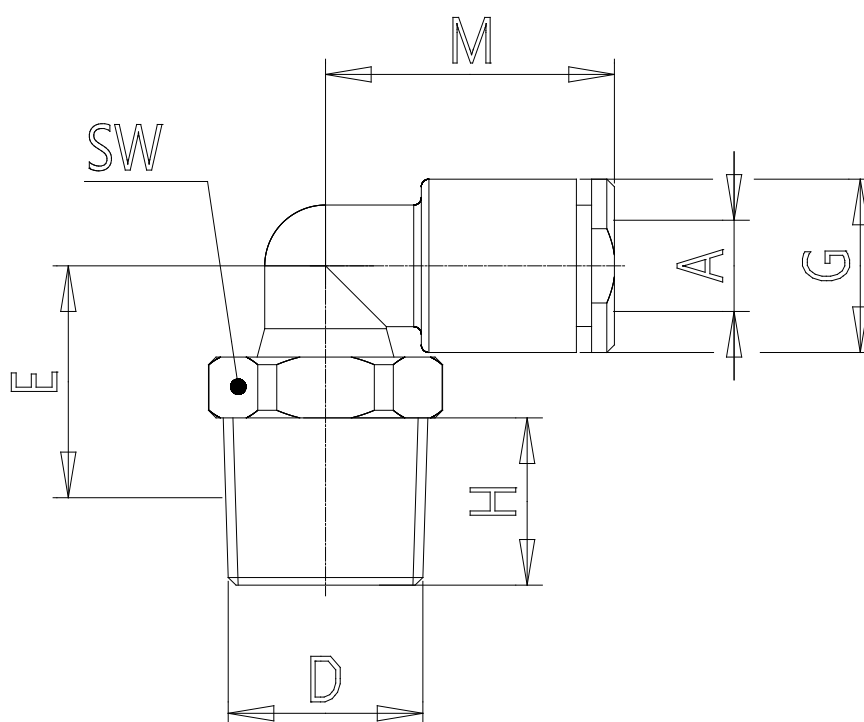

### DIMENSIONS

<b>A (mm)</b>	4
<b>D</b>	R1/4
<b>E (mm)</b>	14.5
<b>G (mm)</b>	9.2
<b>H (mm)</b>	11.0
<b>M (mm)</b>	17.0
<b>SW (mm)</b>	14
<b>Weight (g)</b>	10