

## Mod. G7520 - Fittings Series 7000 - Automation

Product code: G7520 6-3/8

Datasheet creation date: 10/03/2025 09:13

Check the most updated document online [click here](#)



### ■ TECHNICAL DATA

Mod.	G7520 6-3/8
------	-------------

## Mod. G7520 - Fittings Series 7000 - Automation

Product code: G7520 6-3/8

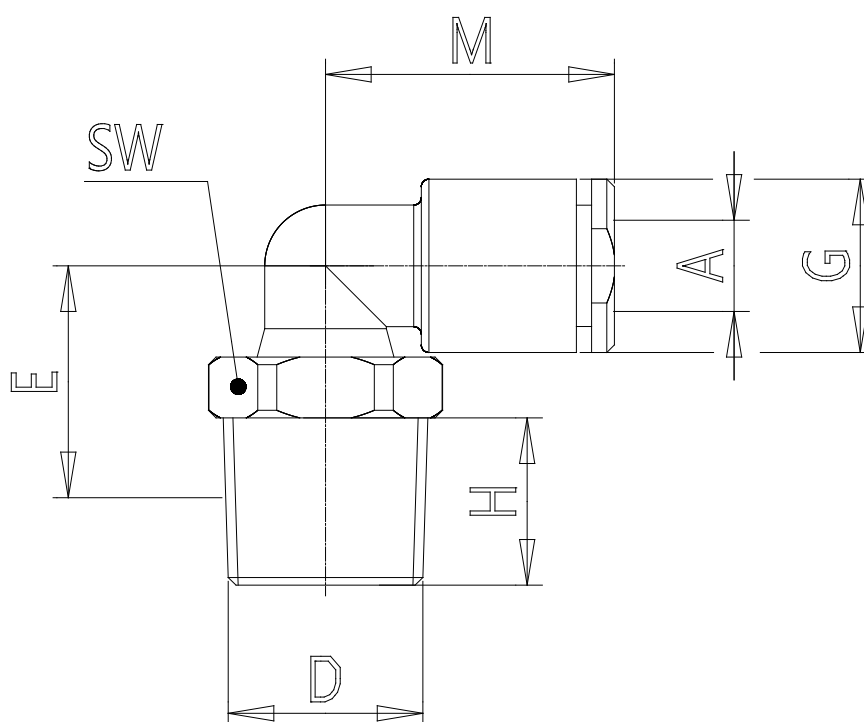

### DIMENSIONS

<b>A (mm)</b>	6
<b>D</b>	R3/8
<b>E (mm)</b>	16.7
<b>G (mm)</b>	11.4
<b>H (mm)</b>	11.5
<b>M (mm)</b>	19.0
<b>SW (mm)</b>	19
<b>Weight (g)</b>	18