

Mod. G7522 - Fittings Series 7000 - Automation

Product code: G7522 10-1/4

Datasheet creation date: 20/05/2026 08:25

Check the most updated document online [click here](#)



TECHNICAL DATA

Mod.	G7522 10-1/4
------	--------------

Mod. G7522 - Fittings Series 7000 - Automation

Product code: G7522 10-1/4

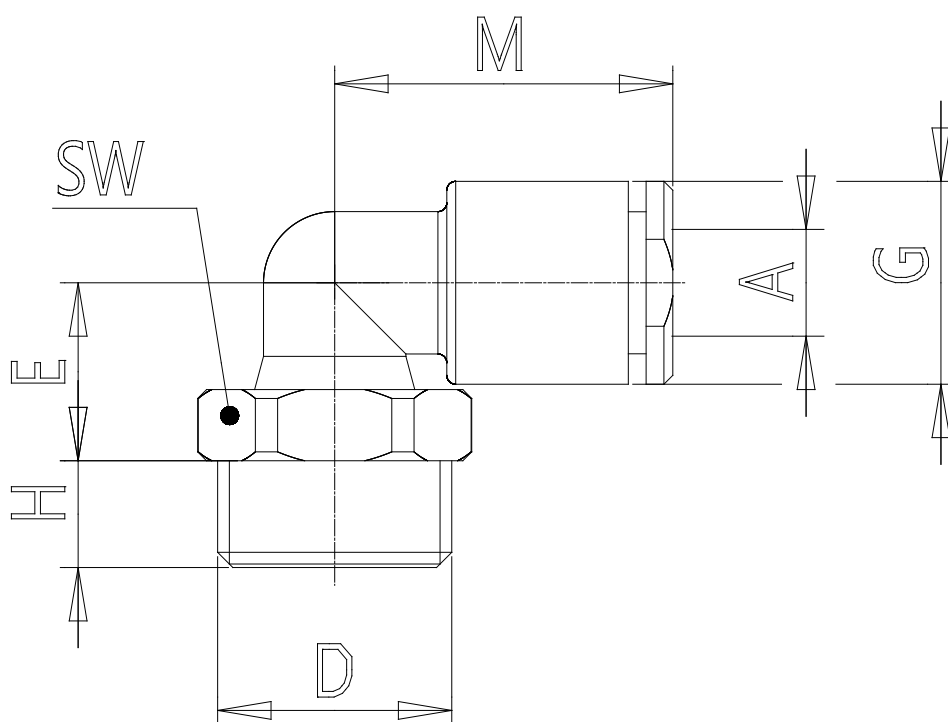

DIMENSIONS

A (mm)	10
D	G1/4
E (mm)	14.5
G (mm)	16.3
H (mm)	6.0
M (mm)	25.0
SW (mm)	14
Weight (g)	16