

## Mod. G7522 - Fittings Series 7000 - Automation

Product code: G7522 12-3/8

Datasheet creation date: 20/05/2026 08:18

Check the most updated document online [click here](#)



### TECHNICAL DATA

Mod.	G7522 12-3/8
------	--------------

## Mod. G7522 - Fittings Series 7000 - Automation

Product code: G7522 12-3/8

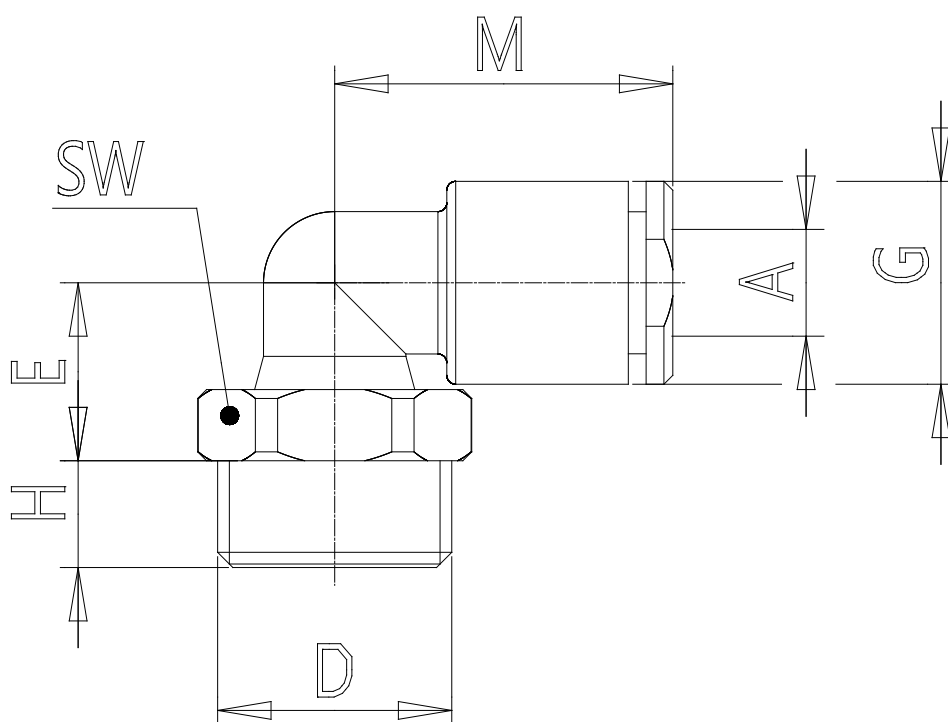

### DIMENSIONS

<b>A (mm)</b>	12
<b>D</b>	G3/8
<b>E (mm)</b>	14.5
<b>G (mm)</b>	20.0
<b>H (mm)</b>	7.0
<b>M (mm)</b>	31.0
<b>SW (mm)</b>	19
<b>Weight (g)</b>	24