

Mod. G7522 - Fittings Series 7000 - Automation

Product code: G7522 6-3/8

Datasheet creation date: 10/03/2025 09:13

Check the most updated document online [click here](#)



■ TECHNICAL DATA

Mod.	G7522 6-3/8
------	-------------

Mod. G7522 - Fittings Series 7000 - Automation

Product code: G7522 6-3/8

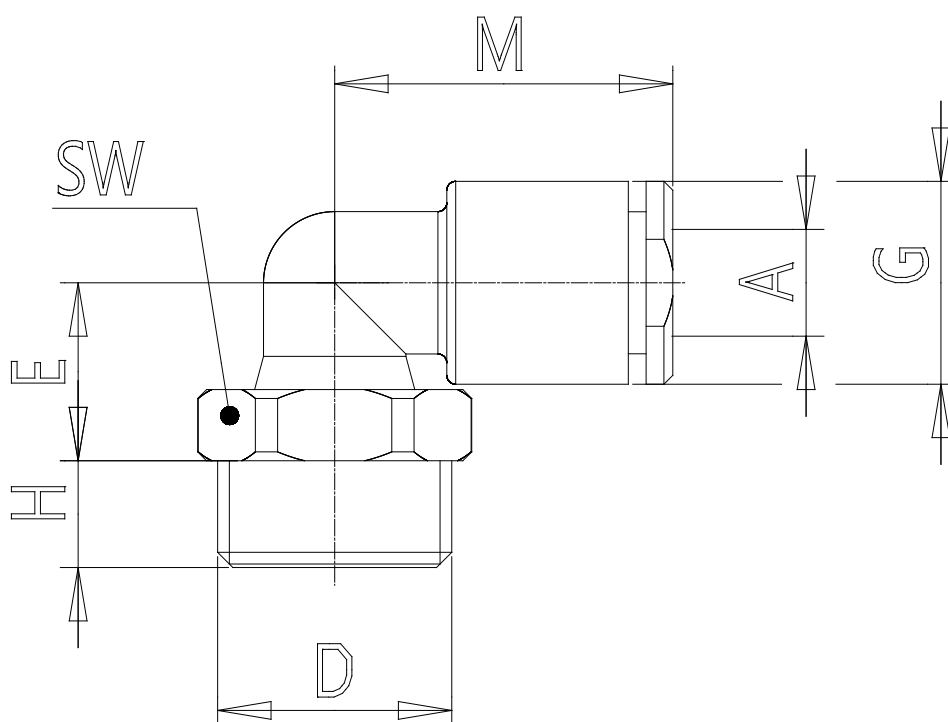

DIMENSIONS

A (mm)	6
D	G3/8
E (mm)	10.0
G (mm)	11.4
H (mm)	7.0
M (mm)	19.0
SW (mm)	19
Weight (g)	16