

Mod. G7522 - Fittings Series 7000 - Automation

Product code: G7522 8-1/4

Datasheet creation date: 10/03/2025 09:13

Check the most updated document online [click here](#)



TECHNICAL DATA

Mod.	G7522 8-1/4
------	-------------

Mod. G7522 - Fittings Series 7000 - Automation

Product code: G7522 8-1/4

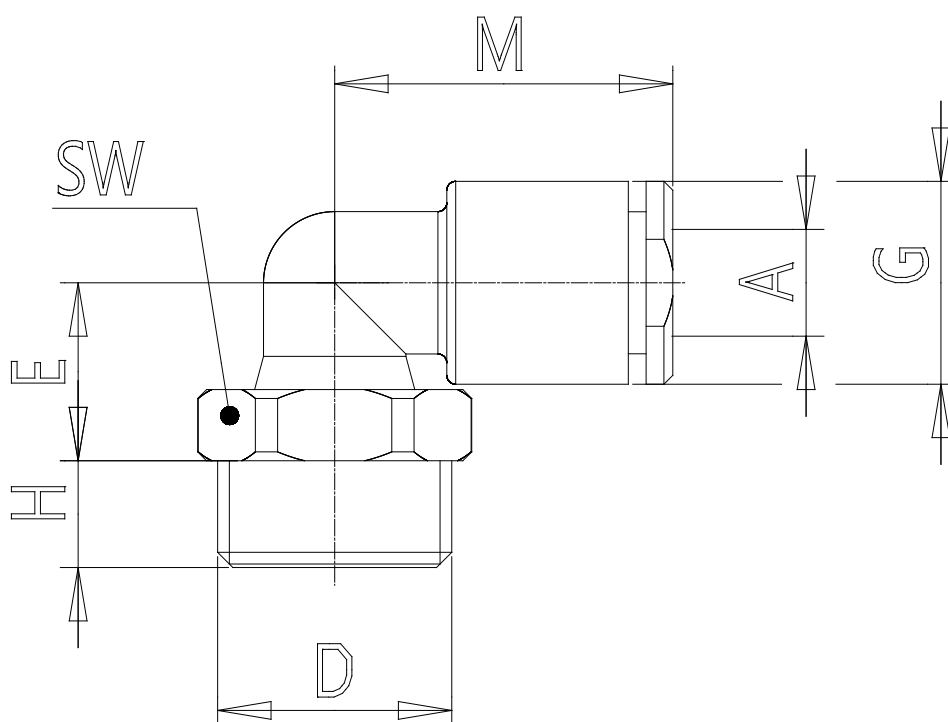

DIMENSIONS

A (mm)	8
D	G1/4
E (mm)	12.0
G (mm)	13.7
H (mm)	6.0
M (mm)	21.5
SW (mm)	14
Weight (g)	14