

Mod. G7523 - Fittings Series 7000 - Automation

Product code: G7523 10-3/8

Datasheet creation date: 20/05/2026 08:19

Check the most updated document online [click here](#)



TECHNICAL DATA

Mod.	G7523 10-3/8
------	--------------

Mod. G7523 - Fittings Series 7000 - Automation

Product code: G7523 10-3/8

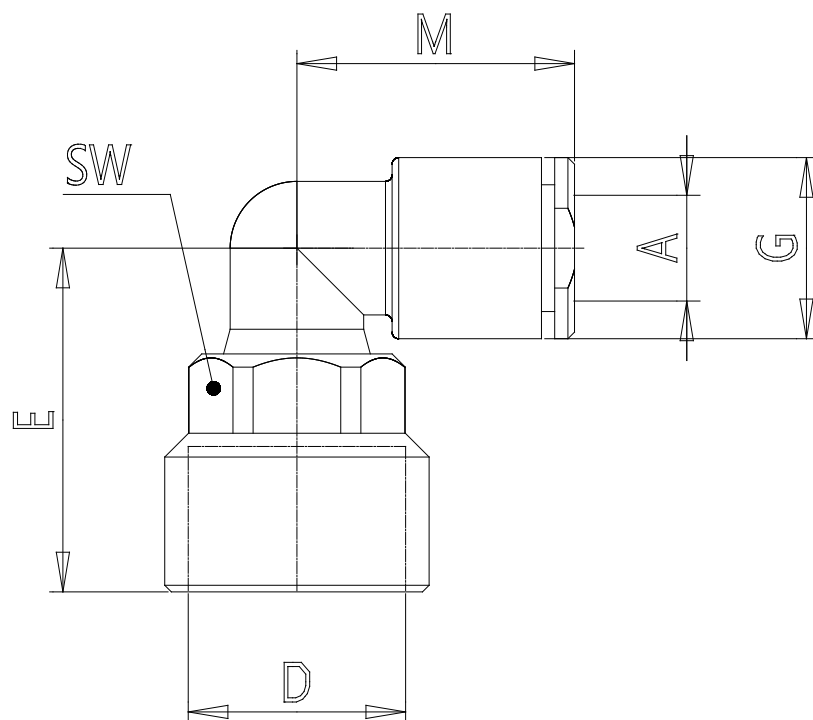

DIMENSIONS

A (mm)	10
D	G3/8
E (mm)	24.5
G (mm)	16.3
M (mm)	25.0
SW (mm)	19
Weight (g)	30