

Mod. G7540 - Fittings Series 7000 - Automation

Product code: G7540 10

Datasheet creation date: 20/05/2026 08:18

Check the most updated document online [click here](#)



■ TECHNICAL DATA

Mod.	G7540 10
------	----------

Mod. G7540 - Fittings Series 7000 - Automation

Product code: G7540 10

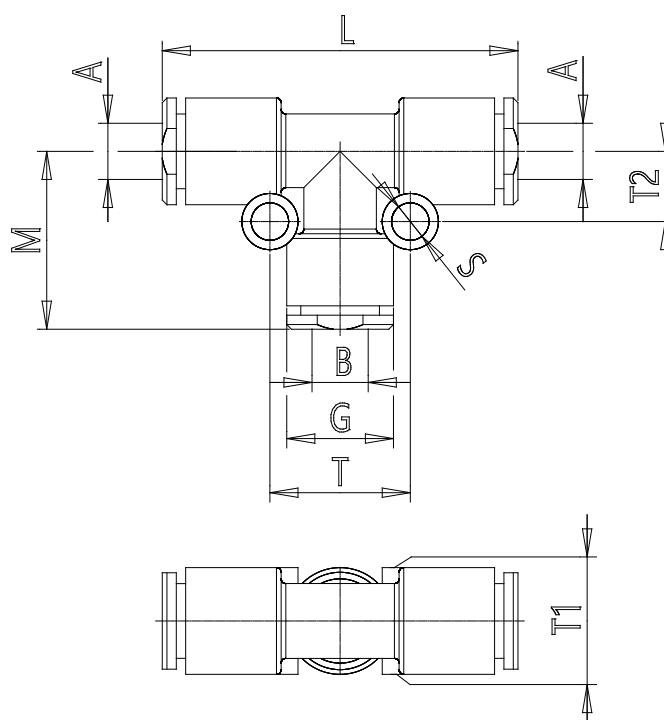

DIMENSIONS

A (mm)	10
B (mm)	10
G (mm)	16.3
L (mm)	50
M (mm)	25.0
S (mm)	4
T (mm)	16.0
T1 (mm)	16.3
T2 (mm)	8.0
Weight (g)	16