

## Mod. G7540 - Fittings Series 7000 - Automation

Product code: G7540 16-16-12

Datasheet creation date: 20/05/2026 08:19

Check the most updated document online [click here](#)



### ■ TECHNICAL DATA

Mod.	G7540 16-16-12
------	----------------

## Mod. G7540 - Fittings Series 7000 - Automation

Product code: G7540 16-16-12

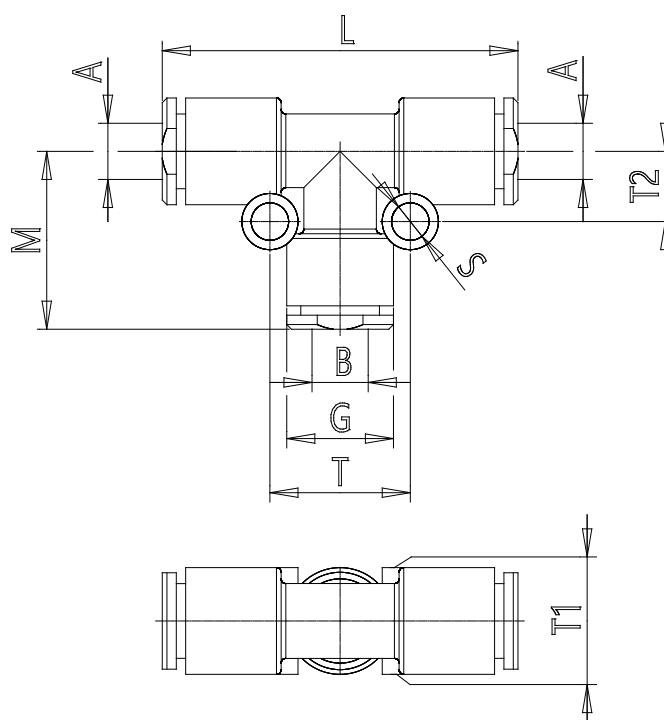

### DIMENSIONS

<b>A (mm)</b>	16
<b>B (mm)</b>	12
<b>G (mm)</b>	27.0
<b>L (mm)</b>	76
<b>M (mm)</b>	38.0
<b>S (mm)</b>	0
<b>T (mm)</b>	0.0
<b>T1 (mm)</b>	0.0
<b>T2 (mm)</b>	0.0
<b>Weight (g)</b>	62