

## Mod. G7540 - Fittings Series 7000 - Automation

Product code: G7540 6

Datasheet creation date: 10/03/2025 09:14

Check the most updated document online [click here](#)



### ■ TECHNICAL DATA

Mod.	G7540 6
------	---------

## Mod. G7540 - Fittings Series 7000 - Automation

Product code: G7540 6

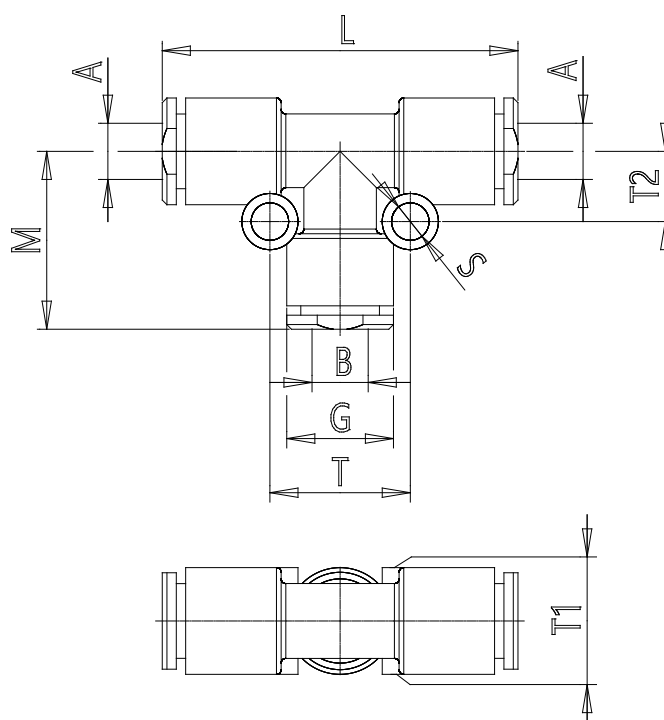

### DIMENSIONS

<b>A (mm)</b>	6
<b>B (mm)</b>	6
<b>G (mm)</b>	11.4
<b>L (mm)</b>	38
<b>M (mm)</b>	19.0
<b>S (mm)</b>	4
<b>T (mm)</b>	15
<b>T1 (mm)</b>	11.4
<b>T2 (mm)</b>	7.5
<b>Weight (g)</b>	9