

Mod. G7545 - Fittings Series 7000 - Automation

Product code: G7545 10-8

Datasheet creation date: 20/05/2026 08:19

Check the most updated document online [click here](#)



TECHNICAL DATA

Mod.	G7545 10-8
------	------------

Mod. G7545 - Fittings Series 7000 - Automation

Product code: G7545 10-8

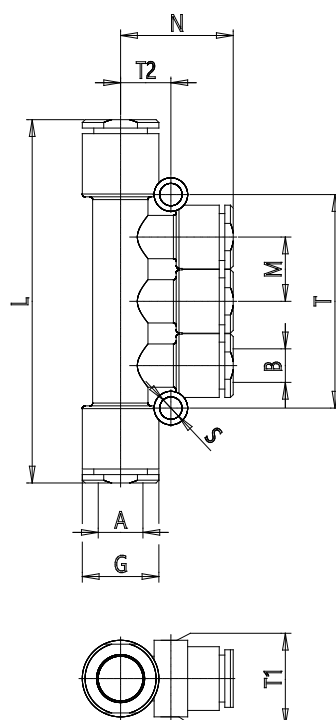

DIMENSIONS

A (mm)	10
B (mm)	8
G (mm)	16.3
L (mm)	80.5
M (mm)	14.1
N (mm)	30.0
T (mm)	45.8
T1 (mm)	16.3
T2 (mm)	10.3
Weight (g)	14