

Mod. G7545 - Fittings Series 7000 - Automation

Product code: G7545 6-4

Datasheet creation date: 10/03/2025 09:14

Check the most updated document online [click here](#)



■ TECHNICAL DATA

Mod.	G7545 6-4
------	-----------

Mod. G7545 - Fittings Series 7000 - Automation

Product code: G7545 6-4

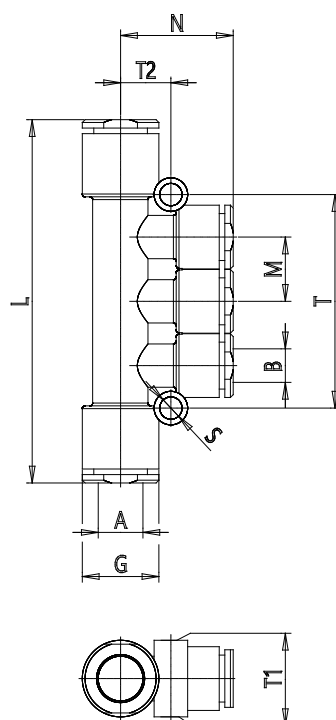

DIMENSIONS

A (mm)	6
B (mm)	4
G (mm)	11.4
L (mm)	56
M (mm)	9.6
N (mm)	26.7
T (mm)	32.5
T1 (mm)	11.6
T2 (mm)	7.5
Weight (g)	12