

Mod. G7550 - Fittings Series 7000 - Automation

Product code: G7550 16

Datasheet creation date: 20/05/2026 08:19

Check the most updated document online [click here](#)



■ TECHNICAL DATA

Mod.	G7550 16
------	----------

Mod. G7550 - Fittings Series 7000 - Automation

Product code: G7550 16

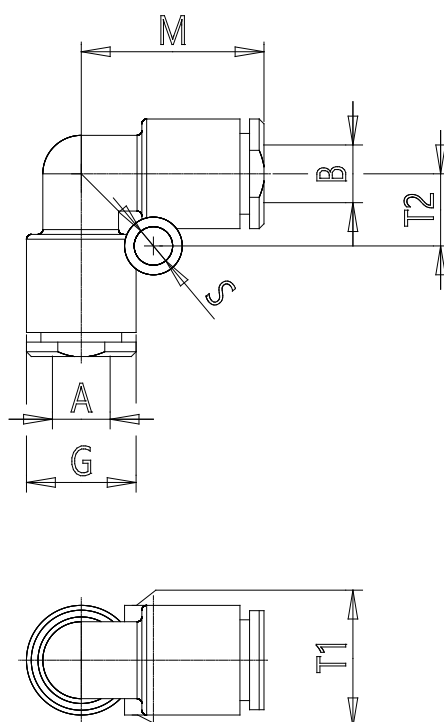

DIMENSIONS

A (mm)	16
B (mm)	16
GD (mm)	27.0
M (mm)	38.0
S (mm)	0
T1 (mm)	27.0
T2 (mm)	0.0
Weight (g)	23