

Mod. G7550 - Fittings Series 7000 - Automation

Product code: G7550 4

Datasheet creation date: 10/03/2025 09:14

Check the most updated document online [click here](#)



■ TECHNICAL DATA

Mod.	G7550 4
------	---------

Mod. G7550 - Fittings Series 7000 - Automation

Product code: G7550 4

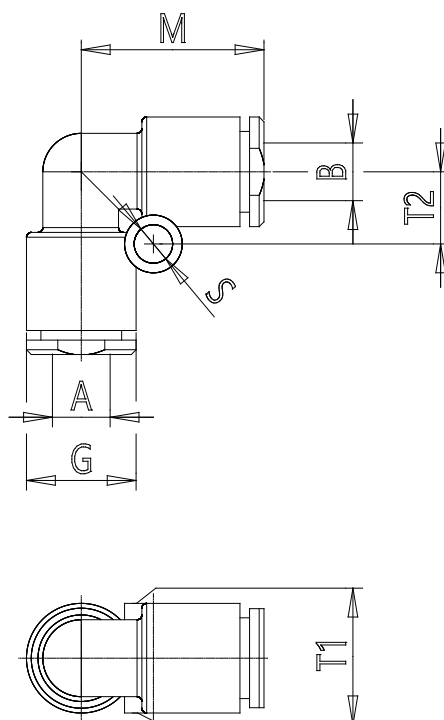

DIMENSIONS

A (mm)	4
B (mm)	4
G (mm)	9.2
M (mm)	17.0
S (mm)	4
T1 (mm)	9.2
T2 (mm)	6.5
Weight (g)	4