

## Mod. G7560 - Fittings Series 7000 - Automation

Product code: G7560 4

Datasheet creation date: 10/03/2025 09:14

Check the most updated document online [click here](#)



### ■ TECHNICAL DATA

Mod.	G7560 4
------	---------

## Mod. G7560 - Fittings Series 7000 - Automation

Product code: G7560 4

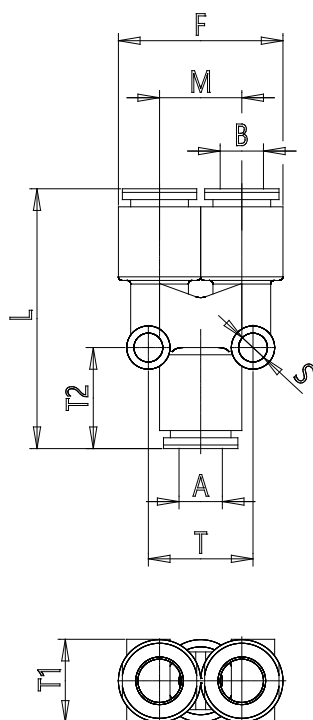

### DIMENSIONS

<b>A (mm)</b>	4
<b>B (mm)</b>	4
<b>E (mm)</b>	19.7
<b>F (mm)</b>	18.2
<b>H (mm)</b>	7.5
<b>L (mm)</b>	33.2
<b>M (mm)</b>	9.0
<b>S (mm)</b>	4
<b>T (mm)</b>	10.8
<b>T1 (mm)</b>	9.5
<b>T2 (mm)</b>	13
<b>Weight (g)</b>	6