

Mod. G7572 - Fittings Series 7000 - Automation

Product code: G7572 4-1/4

Datasheet creation date: 10/03/2025 09:15

Check the most updated document online [click here](#)



TECHNICAL DATA

Mod.	G7572 4-1/4
------	-------------

Mod. G7572 - Fittings Series 7000 - Automation

Product code: G7572 4-1/4

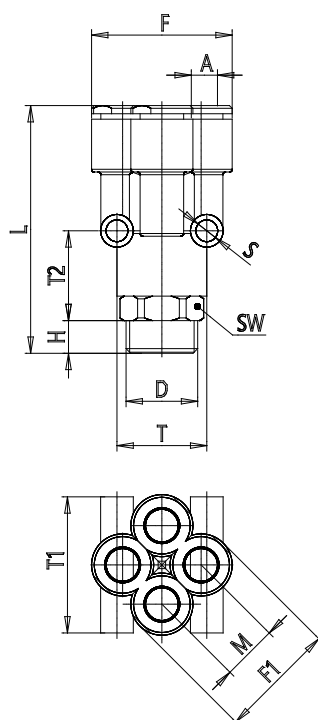

DIMENSIONS

A (mm)	4
D	G1/4
F (mm)	20
H (mm)	6
L (mm)	41.0
M (mm)	8.3
S (mm)	4
T (mm)	14.5
T1 (mm)	20
T2 (mm)	15.0
Weight (g)	21