

Mod. G7575 - Fittings Series 7000 - Automation

Product code: G7575 6-4

Datasheet creation date: 10/03/2025 09:15

Check the most updated document online [click here](#)



■ TECHNICAL DATA

Mod.	G7575 6-4
------	-----------

Mod. G7575 - Fittings Series 7000 - Automation

Product code: G7575 6-4

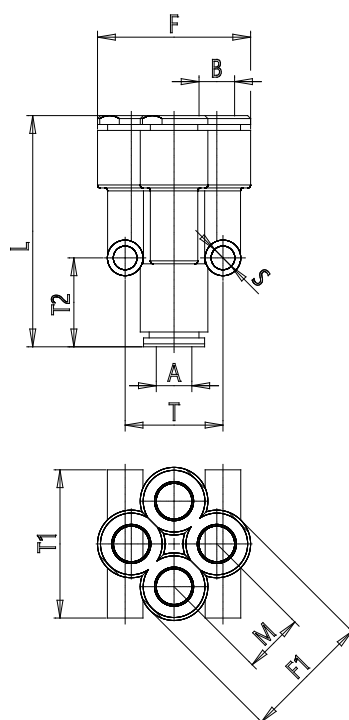

DIMENSIONS

A (mm)	6
B (mm)	4
F (mm)	20.5
F1 (mm)	17
L (mm)	33.6
M (mm)	8.3
S (mm)	4
T (mm)	14.5
T1 (mm)	20.5
T2 (mm)	13.5
Weight (g)	14