

Mod. G7580 - Fittings Series 7000 - Automation

Product code: G7580 10-12

Datasheet creation date: 20/05/2026 08:18

Check the most updated document online [click here](#)



■ TECHNICAL DATA

Mod.	G7580 10-12
------	-------------

Mod. G7580 - Fittings Series 7000 - Automation

Product code: G7580 10-12

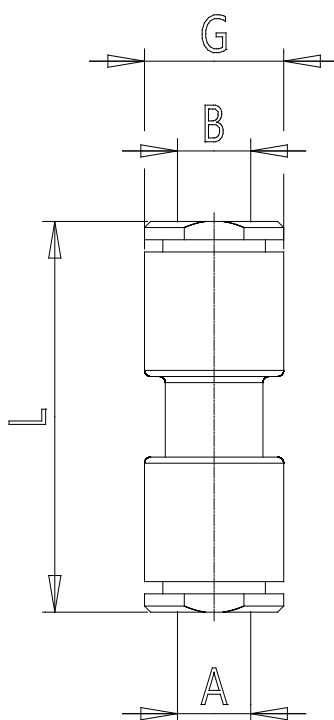

DIMENSIONS

A (mm)	10
B (mm)	12
GD (mm)	20.0
L (mm)	45.5
Weight (g)	9.0