

## Mod. G7580 - Fittings Series 7000 - Automation

Product code: G7580 10

Datasheet creation date: 20/05/2026 08:19

Check the most updated document online [click here](#)



### ■ TECHNICAL DATA

Mod.	G7580 10
------	----------

## Mod. G7580 - Fittings Series 7000 - Automation

Product code: G7580 10

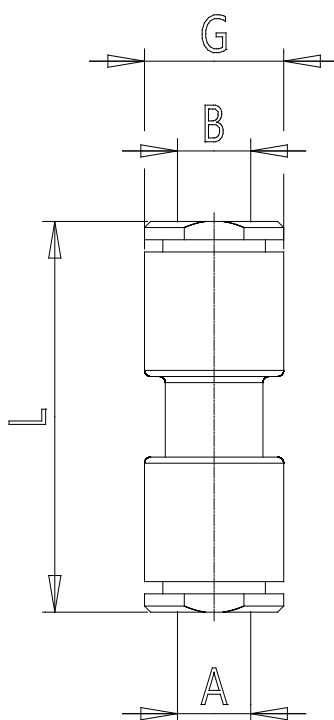

### **DIMENSIONS**

<b>A (mm)</b>	10
<b>B (mm)</b>	10
<b>GD (mm)</b>	16.3
<b>L (mm)</b>	42.0
<b>Weight (g)</b>	5.0