

Mod. G7580 - Fittings Series 7000 - Automation

Product code: G7580 12

Datasheet creation date: 20/05/2026 08:20

Check the most updated document online [click here](#)



■ TECHNICAL DATA

Mod.	G7580 12
------	----------

Mod. G7580 - Fittings Series 7000 - Automation

Product code: G7580 12

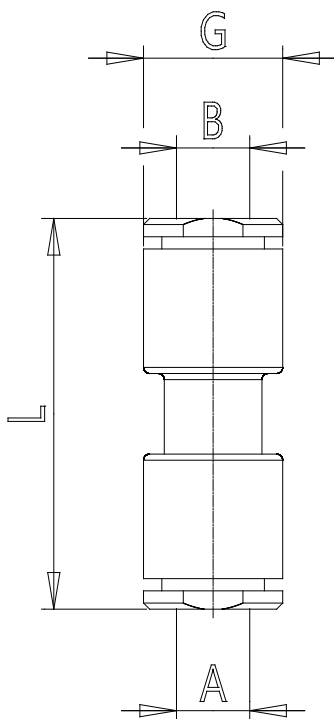

DIMENSIONS

A (mm)	12
B (mm)	12
GD (mm)	20.0
L (mm)	46.0
Weight (g)	9.0