

Mod. G7580 - Fittings Series 7000 - Automation

Product code: G7580 4-8

Datasheet creation date: 10/03/2025 09:15

Check the most updated document online [click here](#)



■ TECHNICAL DATA

Mod.	G7580 4-8
------	-----------

Mod. G7580 - Fittings Series 7000 - Automation

Product code: G7580 4-8

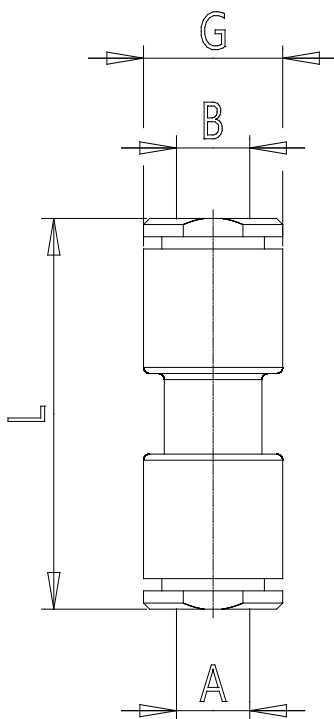

DIMENSIONS

A (mm)	4
B (mm)	8
G (mm)	9.2
L (mm)	34.4
Weight (g)	5