

Mod. G7622 - Fittings Series 7000 - Automation

A(title="()", format=""),D(title="()", format=""),E(title="()", format=""),G(title="()", format=""),H(title="()", format="")

Datasheet creation date: 10/03/2025 09:16

Check the most updated document online [click here](#)



■ TECHNICAL DATA

Mod.	G7622 4-1/8
------	-------------

Mod. G7622 - Fittings Series 7000 - Automation

A(title=" ()", format=""),D(title=" ()", format=""),E(title=" ()", format=""),G(title=" ()", format=""),H(title=" ()", format="")

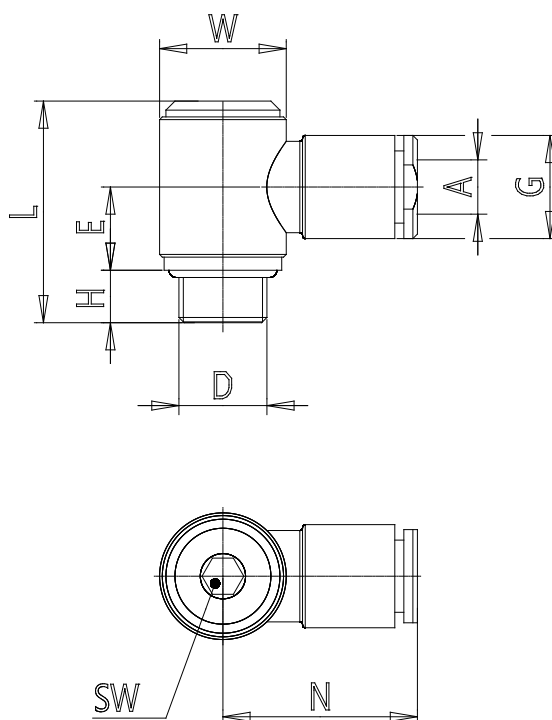

DIMENSIONS

A (mm)	4
D	G1/8
E (mm)	10.0
G (mm)	11.4
H (mm)	5
L (mm)	24.5
N (mm)	21.0
W (mm)	14.0
SW (mm)	4.0
Weight (g)	12