

Mod. G7640 - Fittings Series 7000 - Automation

Product code: G7640 6-1/4

Datasheet creation date: 10/03/2025 09:16

Check the most updated document online [click here](#)



■ TECHNICAL DATA

Mod.	G7640 6-1/4
------	-------------

Mod. G7640 - Fittings Series 7000 - Automation

Product code: G7640 6-1/4

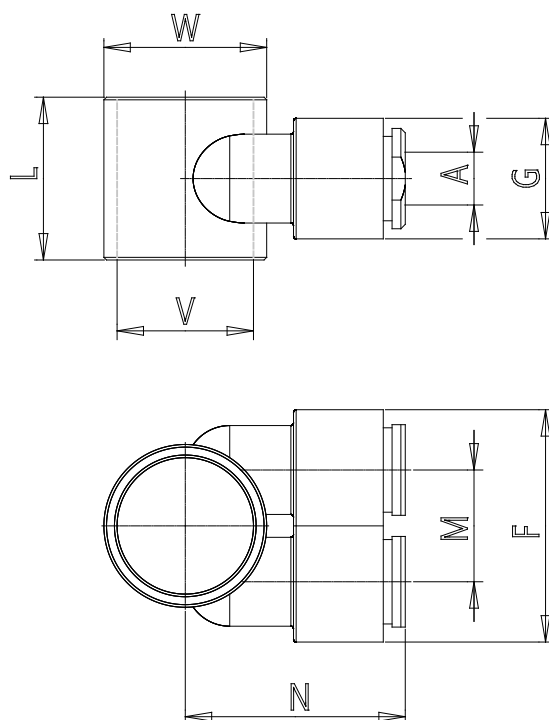

DIMENSIONS

A (mm)	6
F (mm)	26.6
G (mm)	13.7
L (mm)	18.5
M (mm)	12.7
N (mm)	25.0
W (mm)	18.5
Weight (g)	9