

Mod. G7640 - Fittings Series 7000 - Automation

Product code: G7640 6-1/8

Datasheet creation date: 10/03/2025 09:16

Check the most updated document online [click here](#)



■ TECHNICAL DATA

Mod.	G7640 6-1/8
------	-------------

Mod. G7640 - Fittings Series 7000 - Automation

Product code: G7640 6-1/8

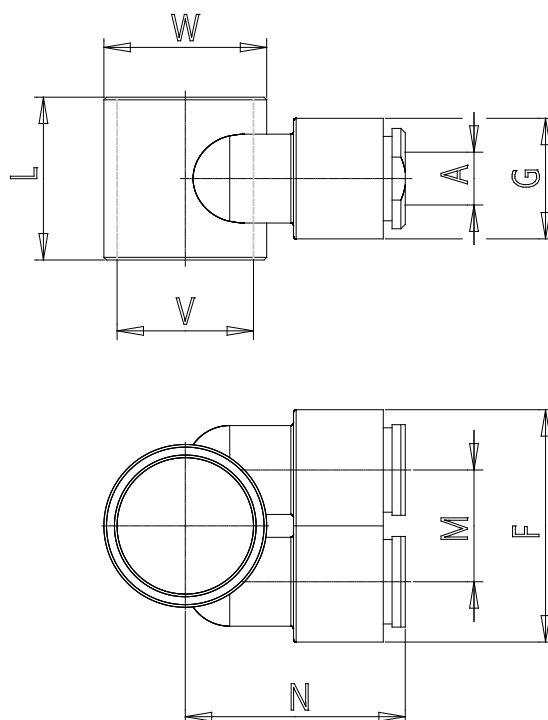

DIMENSIONS

A (mm)	6
F (mm)	22.3
G (mm)	11.4
L (mm)	15.5
M (mm)	10.7
N (mm)	21.5
W (mm)	14.0
Weight (g)	7