

Mod. G7652 - Fittings Series 7000 - Automation

Product code: G7652 4-1/8

Datasheet creation date: 10/03/2025 09:16

Check the most updated document online [click here](#)



TECHNICAL DATA

Mod.	G7652 4-1/8
------	-------------

Mod. G7652 - Fittings Series 7000 - Automation

Product code: G7652 4-1/8

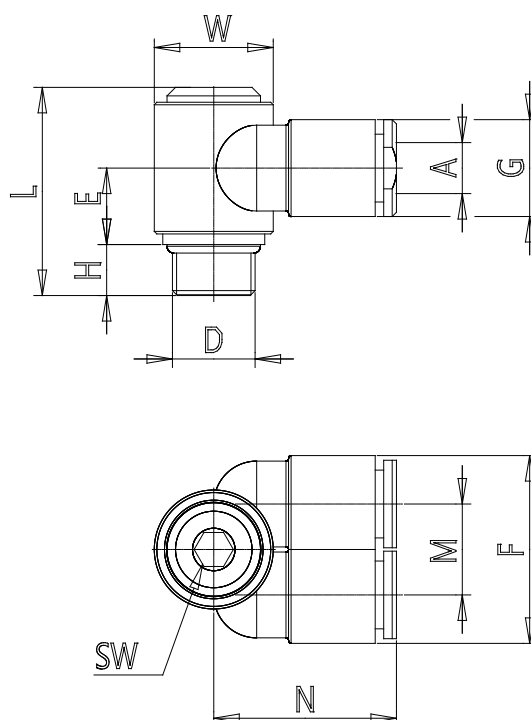

DIMENSIONS

A (mm)	4
D	G1/8
E (mm)	10.0
F (mm)	22.3
G (mm)	11.4
H (mm)	5
L (mm)	24.5
M (mm)	10.7
N (mm)	21.0
W (mm)	14.0
SW (mm)	4
Weight (g)	6