

Mod. G7800 - Fittings Series 7000 - Automation

Product code: G7800 12-16

Datasheet creation date: 20/05/2026 08:19

Check the most updated document online [click here](#)



TECHNICAL DATA

Mod.	G7800 12-16
------	-------------

Mod. G7800 - Fittings Series 7000 - Automation

Product code: G7800 12-16

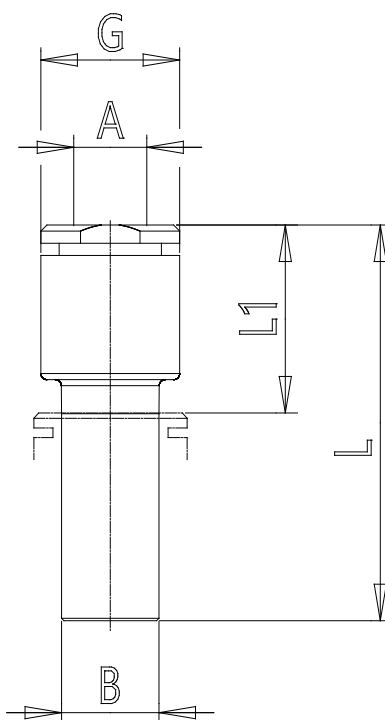

DIMENSIONS

A (mm)	12
B (mm)	16
G (mm)	20.0
L (mm)	49.0
L1 (mm)	23.0
Weight (g)	10.0