

Mod. G7800 - Fittings Series 7000 - Automation

Product code: G7800 4-8

Datasheet creation date: 10/03/2025 09:16

Check the most updated document online [click here](#)



TECHNICAL DATA

Mod.	G7800 4-8
------	-----------

Mod. G7800 - Fittings Series 7000 - Automation

Product code: G7800 4-8

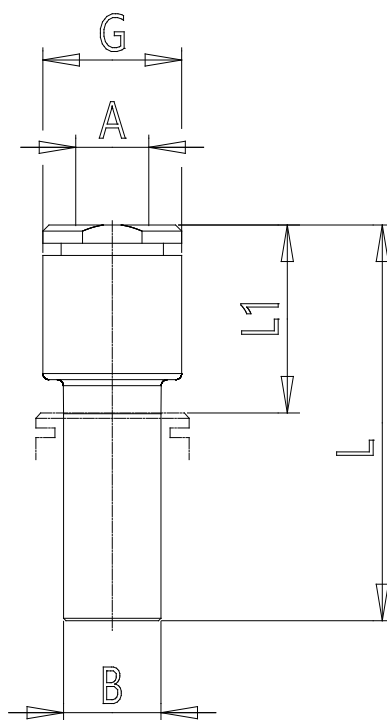

DIMENSIONS

A (mm)	4
B (mm)	8
G (mm)	9.3
L (mm)	30.5
L1 (mm)	14.0
Weight (g)	3