

Planetary gear in line - Mod.GB D

Product code: GB-040-03-D-0024

Datasheet creation date: 07/03/2025 14:31

Check the most updated document online [click here](#)



TECHNICAL DATA

DS (mm)	10
LS (mm)	26
DC (mm)	26
LC (mm)	2
CC (mm)	34
TC x Depth	M4 x 6
EA (mm)	67.5
EB (mm)	60
DG (mm)	40
DM (mm)	8
CM (mm)	66.7
TM x Depth	M4 x 10
Weight (kg)	0.35

Planetary gear in line - Mod.GB D

Product code: GB-040-03-D-0024

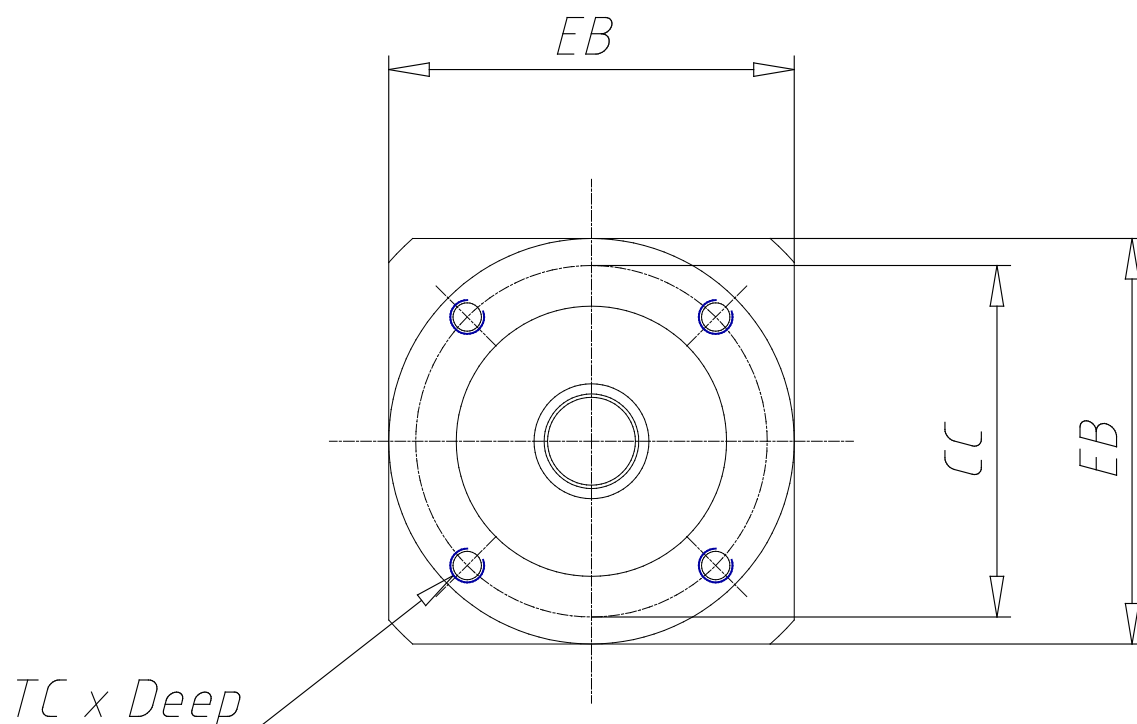

DIMENSIONS

DS (mm)	10
LS (mm)	26
DC (mm)	26
LC (mm)	2
CC (mm)	34
TC x Depth	M4 x 6
EA (mm)	67.5
EB (mm)	60
DG (mm)	40
DM (mm)	8
CM (mm)	66.7
TM x Depth	M4 x 10
Weight (kg)	0.35