

Planetary gear orthogonal - Mod. GB A

Product code: GB-040-07-A-0100

Datasheet creation date: 07/03/2025 15:37

Check the most updated document online [click here](#)



TECHNICAL DATA

| | |
|----------|------------------|
| Mod. | GB-040-07-A-0100 |
| BACKLASH | <21' |

Planetary gear orthogonal - Mod. GB A

Product code: GB-040-07-A-0100

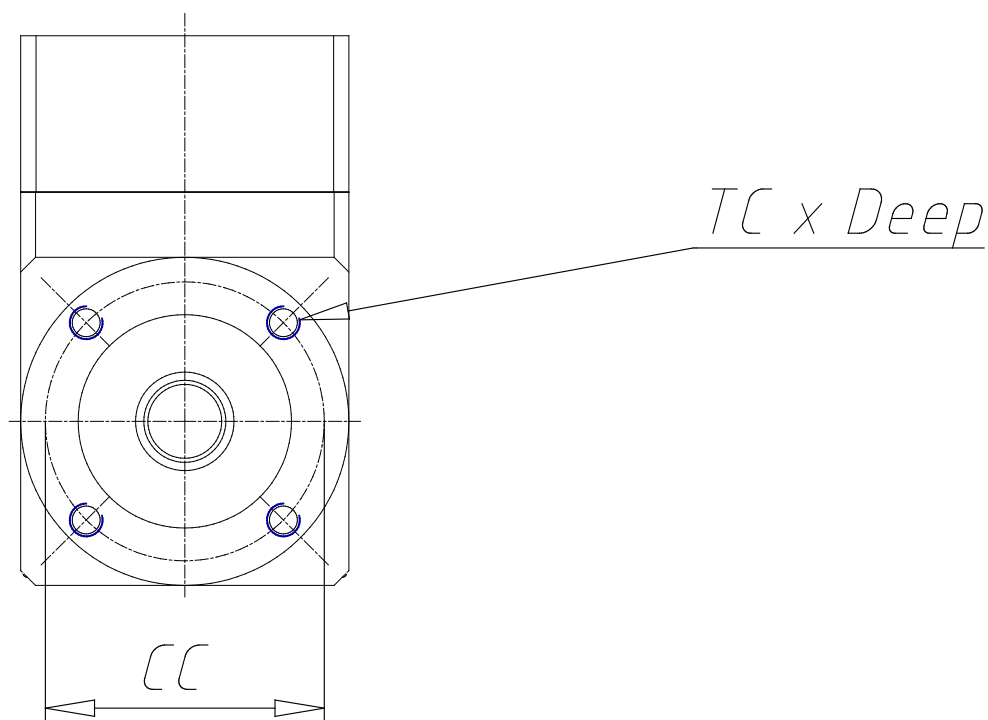

DIMENSIONS

| | |
|-------------|--------|
| DS (mm) | 10 |
| LS (mm) | 26 |
| DC (mm) | 26 |
| LC (mm) | 2 |
| CC (mm) | 34 |
| TC x Depth | M4 x 6 |
| EA (mm) | 84 |
| EB (mm) | 40 |
| EC (mm) | 67.0 |
| DG (mm) | 40 |
| DM (mm) | 8 |
| CM (mm) | 45.0 |
| TM x Depth | M3 x 7 |
| Weight (kg) | 0.51 |