

## Planetary gear in line - Mod.GB D

Product code: GB-080-03-D-0024

Datasheet creation date: 07/03/2025 15:37

Check the most updated document online [click here](#)



### TECHNICAL DATA

<b>DS (mm)</b>	20
<b>LS (mm)</b>	40
<b>DC (mm)</b>	60
<b>LC (mm)</b>	3
<b>CC (mm)</b>	70
<b>TC x Depth</b>	M6 x 10
<b>EA (mm)</b>	93.5
<b>EB (mm)</b>	80
<b>DG (mm)</b>	80
<b>DM (mm)</b>	8
<b>CM (mm)</b>	66.7
<b>TM x Depth</b>	M4 x 10
<b>Weight (kg)</b>	2.10

## Planetary gear in line - Mod.GB D

Product code: GB-080-03-D-0024

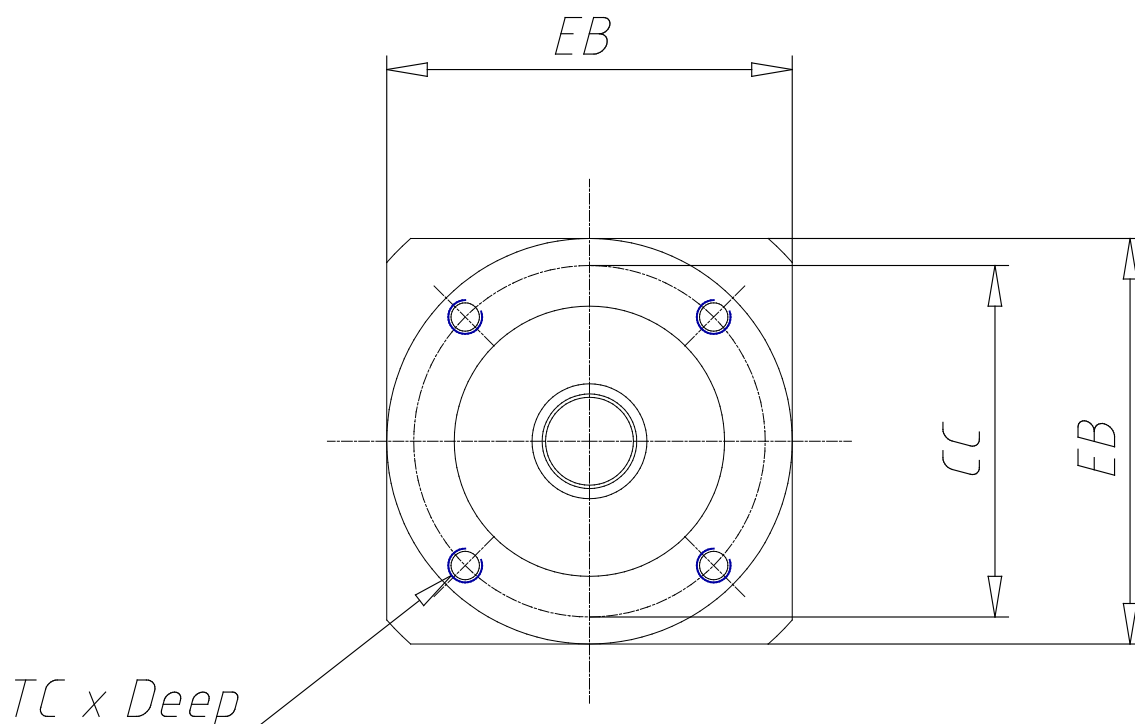

### DIMENSIONS

<b>DS (mm)</b>	20
<b>LS (mm)</b>	40
<b>DC (mm)</b>	60
<b>LC (mm)</b>	3
<b>CC (mm)</b>	70
<b>TC x Depth</b>	M6 x 10
<b>EA (mm)</b>	93.5
<b>EB (mm)</b>	80
<b>DG (mm)</b>	80
<b>DM (mm)</b>	8
<b>CM (mm)</b>	66.7
<b>TM x Depth</b>	M4 x 10
<b>Weight (kg)</b>	2.10