

Planetary gear in line - Mod.GB D

Product code: GB-080-03-D-0750

Datasheet creation date: 07/03/2025 15:37

Check the most updated document online [click here](#)



TECHNICAL DATA

DS (mm)	20
LS (mm)	40
DC (mm)	60
LC (mm)	3
CC (mm)	70
TC x Depth	M6 x 10
EA (mm)	103.5
EB (mm)	80
DG (mm)	80
DM (mm)	19
CM (mm)	90.0
TM x Depth	M6 x 15
Weight (kg)	2.10

Planetary gear in line - Mod.GB D

Product code: GB-080-03-D-0750

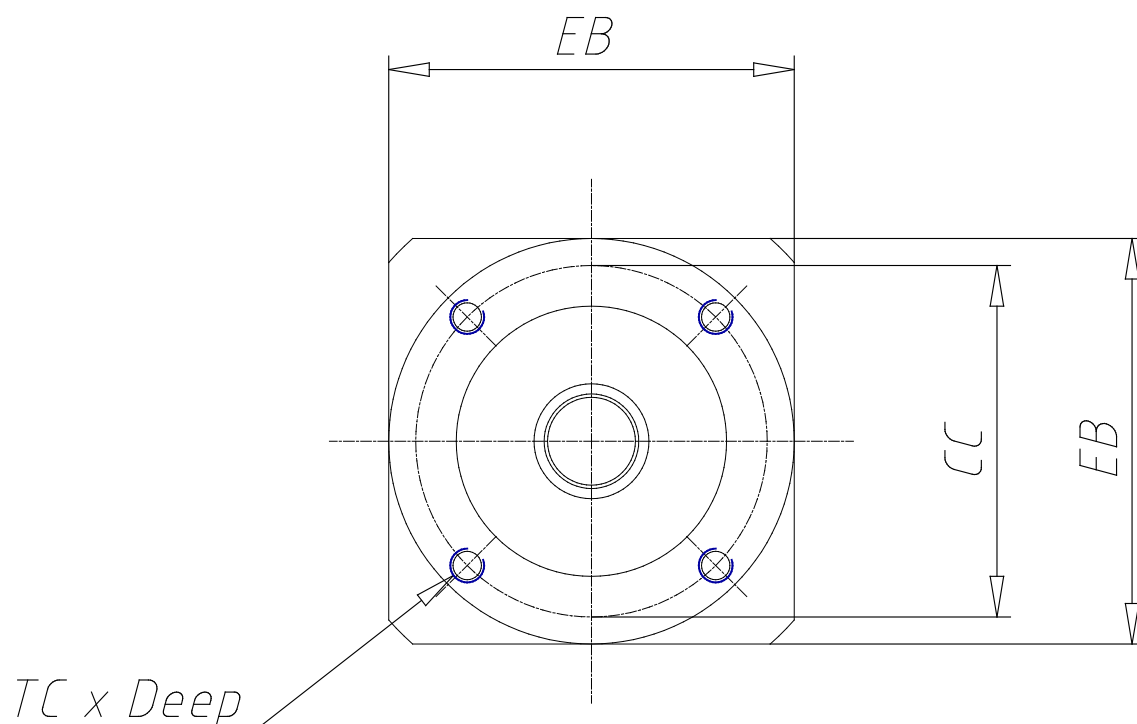

DIMENSIONS

DS (mm)	20
LS (mm)	40
DC (mm)	60
LC (mm)	3
CC (mm)	70
TC x Depth	M6 x 10
EA (mm)	103.5
EB (mm)	80
DG (mm)	80
DM (mm)	19
CM (mm)	90.0
TM x Depth	M6 x 15
Weight (kg)	2.10