

## Planetary gear in line - Mod.GB D

Product code: GB-080-05-D-0024

Datasheet creation date: 07/03/2025 15:37

Check the most updated document online [click here](#)



### TECHNICAL DATA

<b>DS (mm)</b>	20
<b>LS (mm)</b>	40
<b>DC (mm)</b>	60
<b>LC (mm)</b>	3
<b>CC (mm)</b>	70
<b>TC x Depth</b>	M6 x 10
<b>EA (mm)</b>	93.5
<b>EB (mm)</b>	80
<b>DG (mm)</b>	80
<b>DM (mm)</b>	8
<b>CM (mm)</b>	66.7
<b>TM x Depth</b>	M4 x 10
<b>Weight (kg)</b>	2.10

## Planetary gear in line - Mod.GB D

Product code: GB-080-05-D-0024

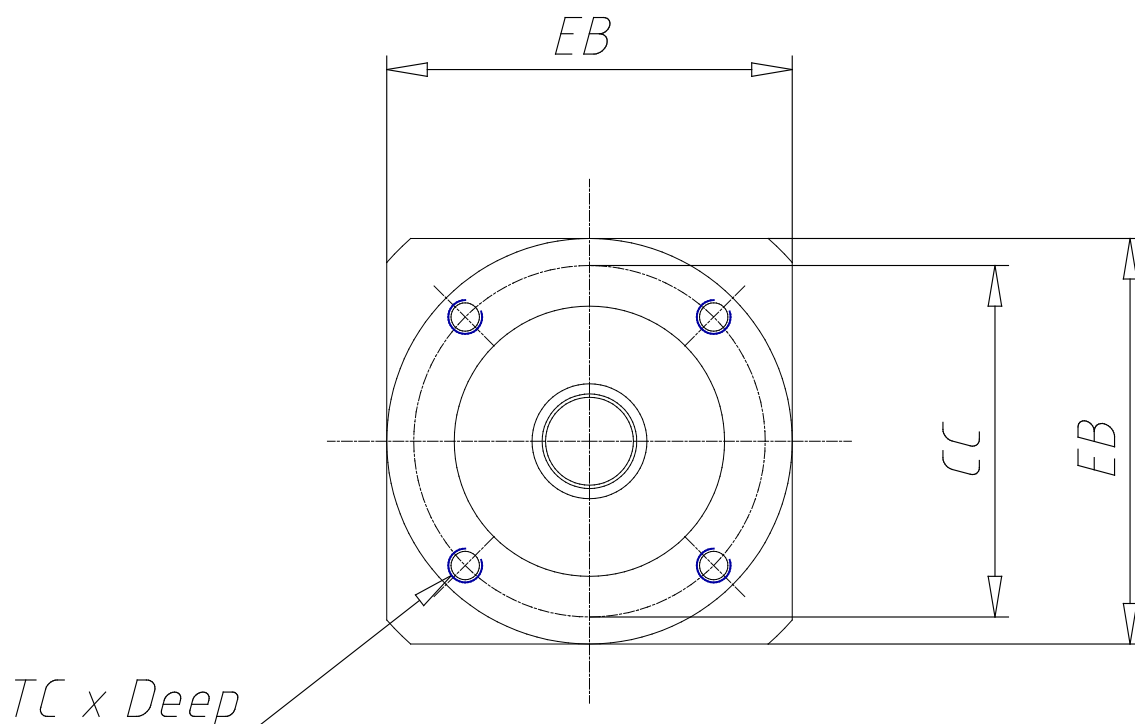

### DIMENSIONS

DS (mm)	20
LS (mm)	40
DC (mm)	60
LC (mm)	3
CC (mm)	70
TC x Depth	M6 x 10
EA (mm)	93.5
EB (mm)	80
DG (mm)	80
DM (mm)	8
CM (mm)	66.7
TM x Depth	M4 x 10
Weight (kg)	2.10