

Planetary gear in line - Mod.GB D

Product code: GB-120-07-D-1000

Datasheet creation date: 07/03/2025 15:38

Check the most updated document online [click here](#)



TECHNICAL DATA

DS (mm)	25
LS (mm)	55
DC (mm)	80
LC (mm)	4
CC (mm)	100
TC x Depth	M10 x 16
EA (mm)	136.5
EB (mm)	130
DG (mm)	115
DM (mm)	24
CM (mm)	145.0
TM x Depth	M8 x 18
Weight (kg)	6.00

Planetary gear in line - Mod.GB D

Product code: GB-120-07-D-1000

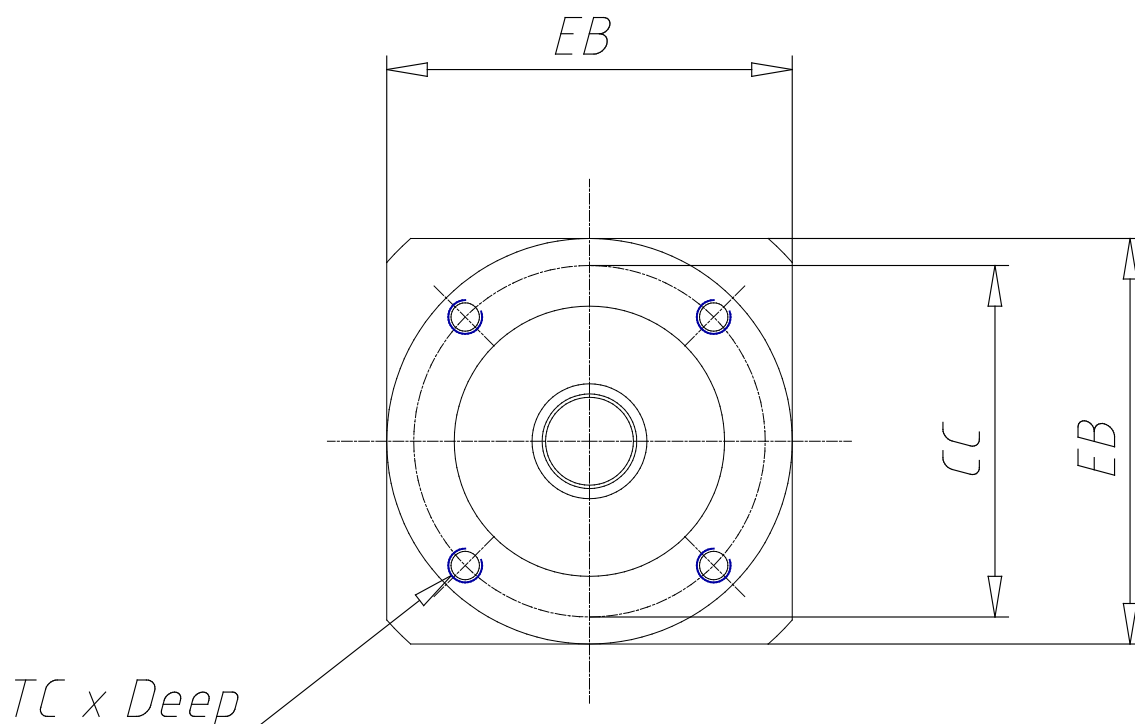

DIMENSIONS

DS (mm)	25
LS (mm)	55
DC (mm)	80
LC (mm)	4
CC (mm)	100
TC x Depth	M10 x 16
EA (mm)	136.5
EB (mm)	130
DG (mm)	115
DM (mm)	24
CM (mm)	145.0
TM x Depth	M8 x 18
Weight (kg)	6.00