

Valves - Series GMCU

Product code: GMCU 904-1/8-8

Datasheet creation date: 10/03/2025 12:11

Check the most updated document online [click here](#)



TECHNICAL DATA

Mod.	GMCU 904-1/8-8
------	----------------

Valves - Series GMCU

Product code: GMCU 904-1/8-8

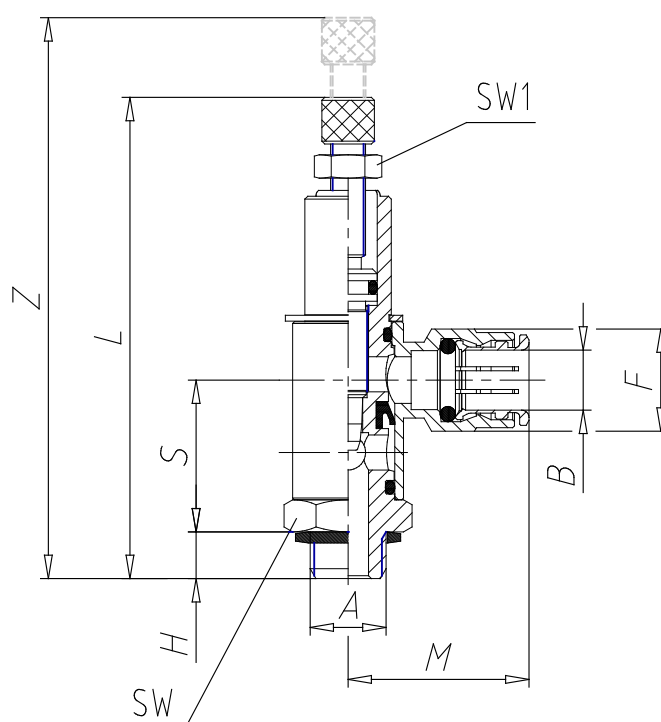

DIMENSIONS

A	G1/8
B (mm)	8
S (mm)	22.5
H (mm)	5
L (mm)	65.5
Z (mm)	72.5
M (mm)	28.0
F (mm)	15.0
SW (mm)	14
SW1 (mm)	7.0