

Valves - Series GSCO

Product code: GSCO 805-1/4-8

Datasheet creation date: 10/03/2025 12:12

Check the most updated document online [click here](#)



TECHNICAL DATA

Mod.	GSCO 805-1/4-8
------	----------------

Valves - Series GSCO

Product code: GSCO 805-1/4-8

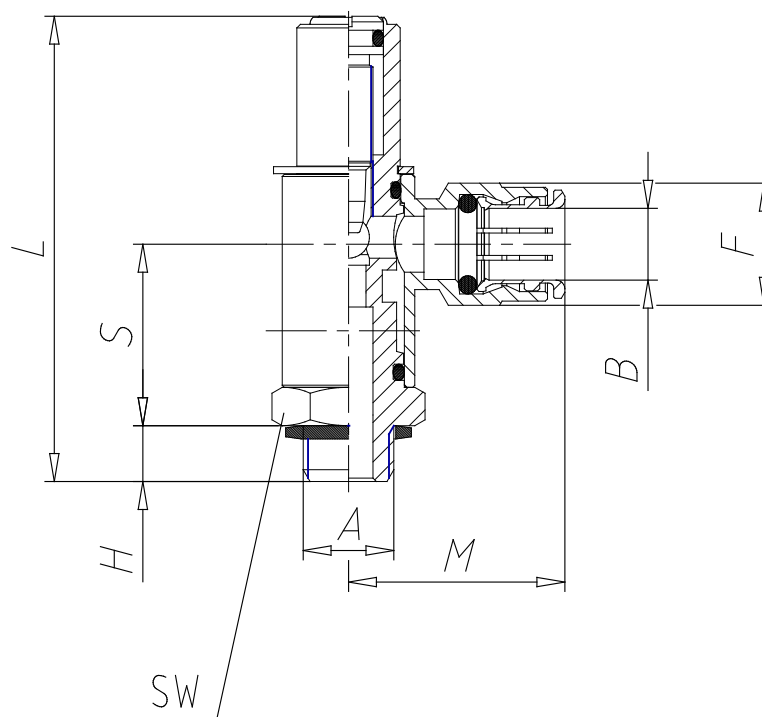

DIMENSIONS

A	G1/4
B (mm)	8
S (mm)	27.0
H (mm)	7
L (mm)	67.5
M (mm)	28.5
F (mm)	15.0
SW (mm)	19