

- Valves Series GSCU

Product code: GSCU 04-02

Datasheet creation date: 10/03/2025 12:12

Check the most updated document online [click here](#)



TECHNICAL DATA

Mod.	GSCU 04-02
------	------------

- Valves Series GSCU

Product code: GSCU 04-02

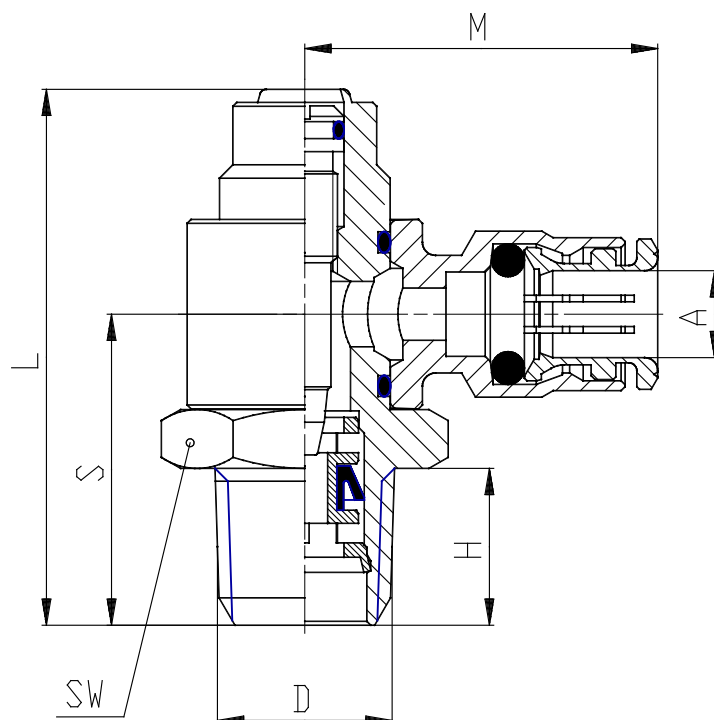

DIMENSIONS

A	1/4
D (NPTF) (INCH)	1/8
S (INCH)	0.787
H (INCH)	0.315
L (INCH)	1.449
Z (INCH)	2.008
M (INCH)	0.965
SW (INCH)	0.551