

- Valves Series GSCU

Product code: GSCU 04-04

Datasheet creation date: 10/03/2025 12:12

Check the most updated document online [click here](#)



TECHNICAL DATA

Mod.	GSCU 04-04
------	------------

- Valves Series GSCU

Product code: GSCU 04-04

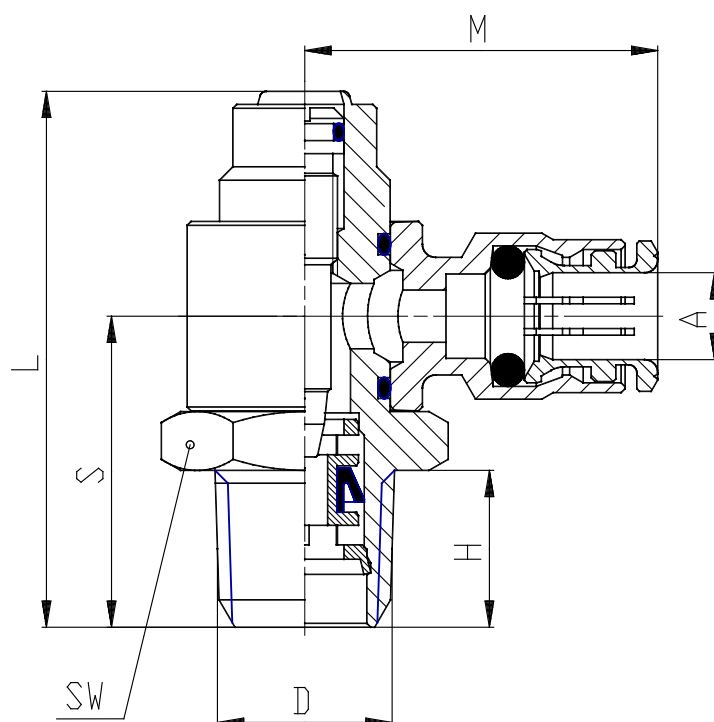

DIMENSIONS

A	1/4
D (NPTF) (INCH)	1/4
S (INCH)	0.945
H (INCH)	0.472
L (INCH)	1.614
Z (INCH)	2.224
M (INCH)	1.043
SW (INCH)	0.748