

- Serie GSCU_F

Product code: GSCU 04F-04

Datasheet creation date: 10/03/2025 12:12

Check the most updated document online [click here](#)



TECHNICAL DATA

Mod.	GSCU 04F-04
------	-------------

- Serie GSCU_F

Product code: GSCU 04F-04

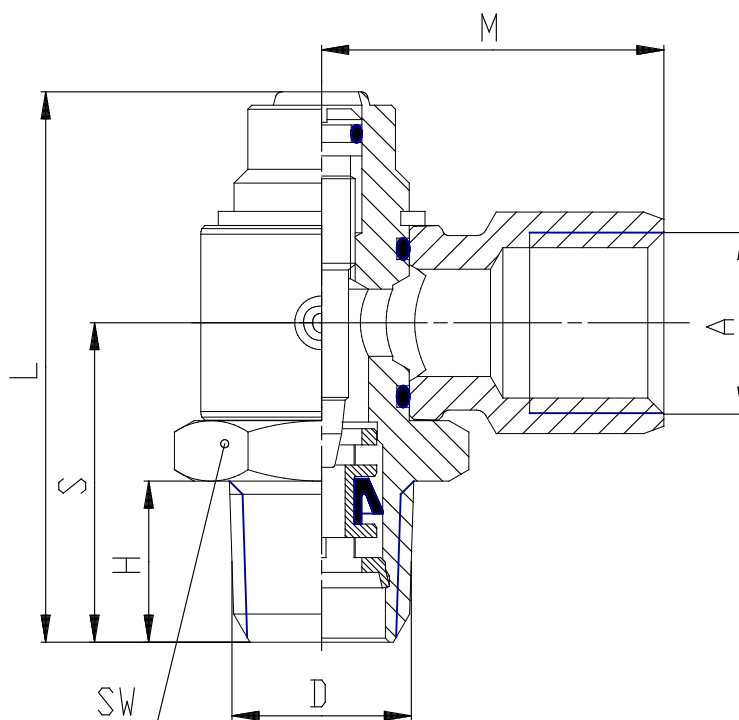

DIMENSIONS

A	1/4
D NPTF (INCH)	1/4
H (INCH)	0.472
S (INCH)	0.925
L (INCH)	1.614
M (INCH)	1.004
(INCH)	0.748