

## Mod. HP6512 - Series HP6000 fittings

Product code: HP6512 4-M10X1

Datasheet creation date: 10/03/2025 02:42

Check the most updated document online [click here](#)



### ■ TECHNICAL DATA

Mod.	HP6512 4-M10X1
------	----------------

## Mod. HP6512 - Series HP6000 fittings

Product code: HP6512 4-M10X1

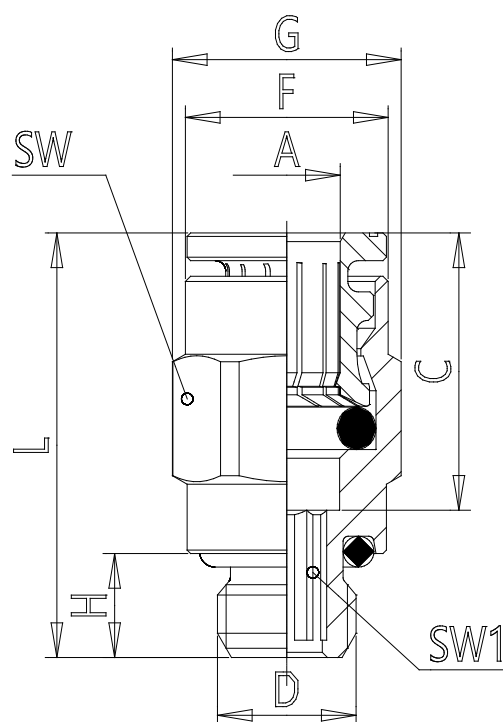

### DIMENSIONS

<b>A (mm)</b>	4
<b>D (mm)</b>	M10x1
<b>C (mm)</b>	14
<b>F (mm)</b>	8.8
<b>G (mm)</b>	13.5
<b>H (mm)</b>	6.0
<b>L (mm)</b>	19.0
<b>SW (mm)</b>	12
<b>SW1 (mm)</b>	2.5
<b>Weight (g)</b>	10