

Mod. HP6512 - Series HP6000 fittings

Product code: HP6512 4-M12X1

Datasheet creation date: 10/03/2025 02:42

Check the most updated document online [click here](#)



■ TECHNICAL DATA

Mod.	HP6512 4-M12X1
------	----------------

Mod. HP6512 - Series HP6000 fittings

Product code: HP6512 4-M12X1

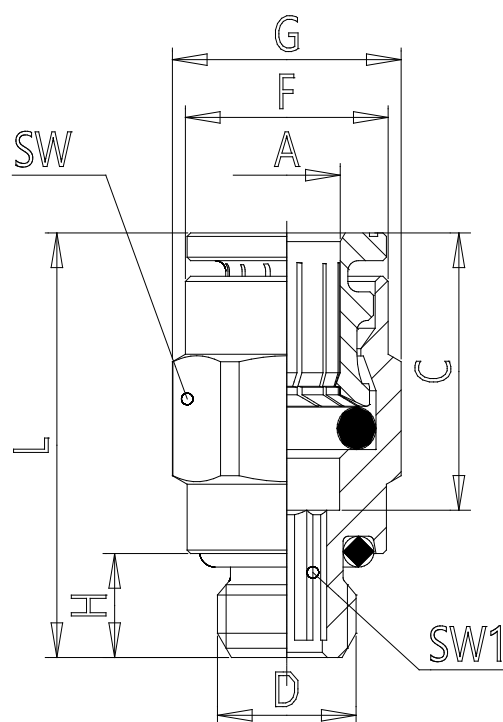

DIMENSIONS

A (mm)	4
D (mm)	M12x1
C (mm)	14
F (mm)	8.8
G (mm)	15.4
H (mm)	7.0
L (mm)	20.0
SW (mm)	14
SW1 (mm)	2.5
Weight (g)	14