

Mod. HP6522 - Series HP6000 fittings

Product code: HP6522 4-1/4

Datasheet creation date: 10/03/2025 02:43

Check the most updated document online [click here](#)



■ TECHNICAL DATA

Mod.	HP6522 4-1/4
------	--------------

Mod. HP6522 - Series HP6000 fittings

Product code: HP6522 4-1/4

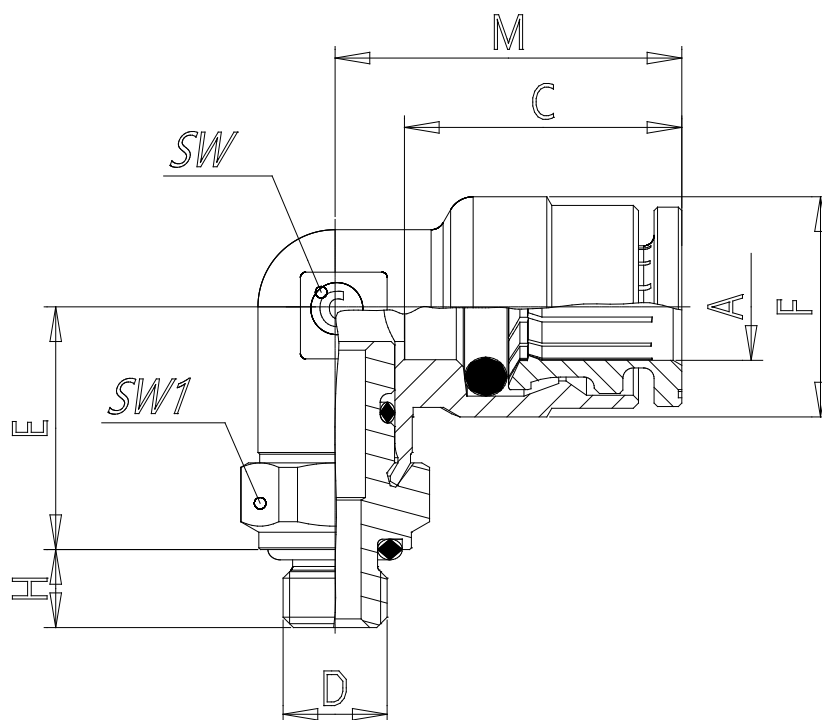

DIMENSIONS

A (mm)	4
D	G1/4
C (mm)	14
E (mm)	15.5
F (mm)	9.0
H (mm)	7.0
M (mm)	17.5
SW (mm)	8
SW1 (mm)	15
Weight (g)	25