

Mod. HP6550 - Series HP6000 fittings

Product code: HP6550 4

Datasheet creation date: 10/03/2025 02:44

Check the most updated document online [click here](#)



TECHNICAL DATA

Mod.	HP6550 4
------	----------

Mod. HP6550 - Series HP6000 fittings

Product code: HP6550 4

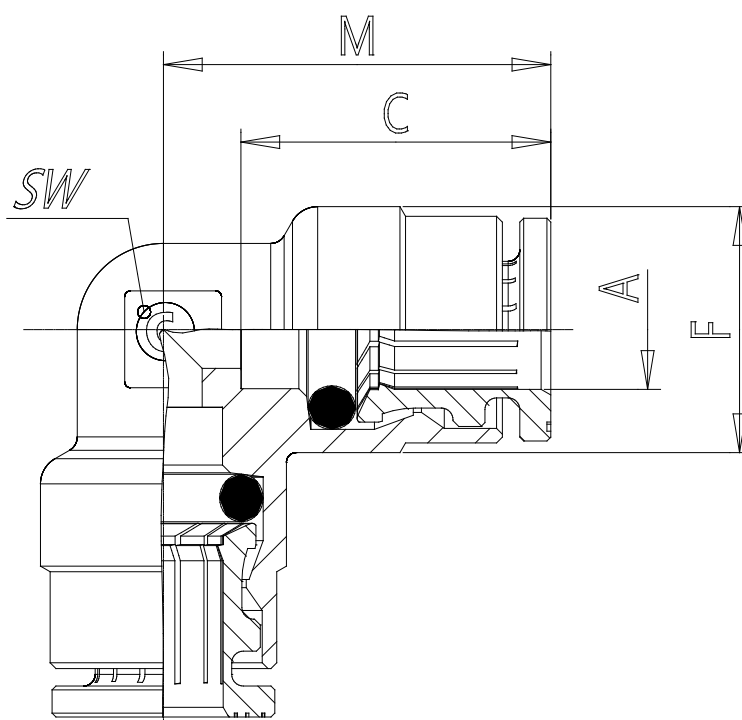

DIMENSIONS

A (mm)	4
C (mm)	14
F (mm)	9.0
M (mm)	17.5
SW (mm)	8
Weight (g)	15