

Mod. HP6580 - Series HP6000 fittings

Product code: HP6580 4

Datasheet creation date: 10/03/2025 02:44

Check the most updated document online [click here](#)



TECHNICAL DATA

Mod.	HP6580 4
------	----------

Mod. HP6580 - Series HP6000 fittings

Product code: HP6580 4

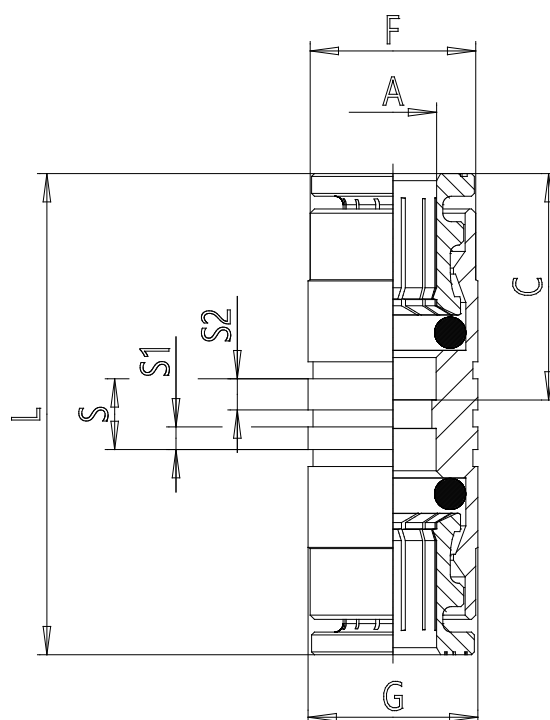

DIMENSIONS

A (mm)	4
C (mm)	14
F (mm)	8.4
G (mm)	9
L (mm)	29
S (mm)	5
S1 (mm)	1.6
S2 (mm)	2.2
Weight (g)	14