

Rear Trunnion bracket - Mod. I

Product code: I-27-25

Datasheet creation date: 07/03/2025 15:56

Check the most updated document online [click here](#)



TECHNICAL DATA

Mod.	I-27-25
------	---------

Rear Trunnion bracket - Mod. I

Product code: I-27-25

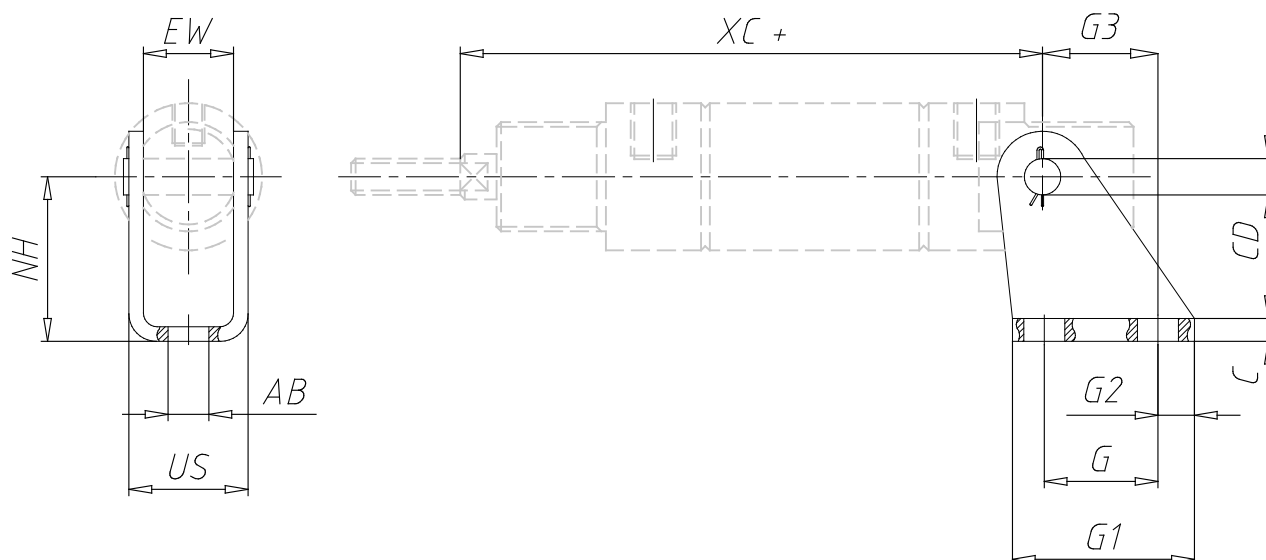

DIMENSIONS

G (mm)	15
G1 (mm)	33
G2 (mm)	9
G3 (mm)	20.0
C (mm)	2.0
XC (mm)	78.5
Ø AB (mm)	6.6
US (mm)	18.0
NH (mm)	22
Ø CD (mm)	8
EW (mm)	14